

M12 T code male moldable connector, unshielded/M12, T型公头成型式连接器, 不带屏蔽

Illustration/尺寸

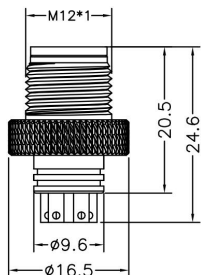

Product photo/产品图



Part number/产品料号

Pins/针数	Code/型	Part number/产品料号
4pins/4针	T code/T型	12C061

Pin assignment front view/针位分布前视图

T code 4pins
T型4针

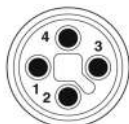

General data/常规数据

Pins Numbers/针数	4pins/4针
Rated voltage/额定电压	630V
Rated current(40°C)/额定电流	12A
Standards/标准	IEC 61076-2-101
Termination/焊接方式	solder/焊接
Degree of protection/防护等级	IP67, IP68, IP69K
Wire gauge(mm²)/线规(平方数)	0.14mm²-0.75mm²
Wire gauge(AWG)/线号(平方数)	26AWG-18AWG
Mechanical operation/插拔次数	>100 mating cycles/大于100次
Ambient temperature (operation)/操作温度	-25°C~+85°C
Contact resistance/接触电阻	≤5mΩ
Insulation resistance/绝缘电阻	≥100MΩ
Connector body/胶芯	TPU
Pins/端子	Brass with gold plated/黄铜镀金
Screw/螺丝	Brass with nickel plated/黄铜镀镍
Environmental compliance/环境符合标准	RoHs, Reach

M12 T code female moldable connector, unshielded/M12, T型母头成型式连接器, 不带屏蔽

Illustration/尺寸

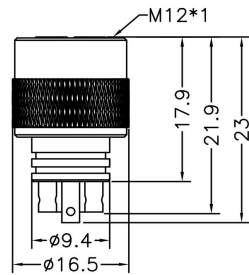

Product photo/产品图



Part number/产品料号

Pins/孔数	Code/型	Part number/产品料号
4pins/4针	T code/T型	12C062

Pin assignment front view/孔位分布前视图

T code 4pins
T型4孔

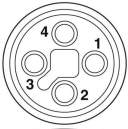

General data/常规数据

Pins Numbers/孔数	4pins/4针
Rated voltage/额定电压	630V
Rated current(40°C)/额定电流	12A
Standards/标准	IEC 61076-2-101
Termination/焊接方式	solder/焊接
Degree of protection/防护等级	IP67, IP68, IP69K
Wire gauge(mm²)/线规(平方数)	0.14mm²-0.75mm²
Wire gauge(AWG)/线号(平方数)	26AWG-18AWG
Mechanical operation/插拔次数	>100 mating cycles/大于100次
Ambient temperature (operation)/操作温度	-25°C~+85°C
Contact resistance/接触电阻	≤5mΩ
Insulation resistance/绝缘电阻	≥100MΩ
Connector body/胶芯	TPU
Pins/端子	Phosphorus copper with gold plated/磷铜镀金
Screw/螺丝	Brass with nickel plated/黄铜镀镍
Gasket/胶圈	Fluorine ring/氟胶圈
Environmental compliance/环境符合标准	RoHs, Reach

M12 T code male moldable connector with shielded/M12, T型公头成型式连接器, 带屏蔽

Illustration/尺寸

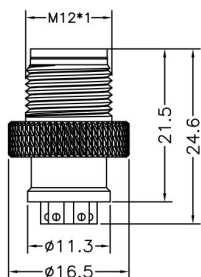

Product photo/产品图



Part number/产品料号

Pins/针数	Code/型	Part number/产品料号
4pins/4针	T code/T型	12C063

Pin assignment front view/针位分布前视图

T code 4pins
T型4针



General data/常规数据

Pins Numbers/针数	4pins/4针
Rated voltage/额定电压	630V
Rated current(40°C)/额定电流	12A
Standards/标准	IEC 61076-2-101
Termination/焊接方式	solder/焊接
Degree of protection/防护等级	IP67, IP68, IP69K
Wire gauge(mm²)/线规(平方数)	0.14mm²-0.75mm²
Wire gauge(AWG)/线号(平方数)	26AWG-18AWG
Mechanical operation/插拔次数	>100 mating cycles/大于100次
Ambient temperature (operation)/操作温度	-25°C~+85°C
Contact resistance/接触电阻	≤5mΩ
Insulation resistance/绝缘电阻	≥100MΩ
Connector body/胶芯	TPU
Pins/端子	Brass with gold plated/黄铜镀金
Screw/螺丝	Brass with nickel plated/黄铜镀镍
Environmental compliance/环境符合标准	RoHs, Reach

M12 T code female moldable connector with shielded/M12, T型母头成型式连接器, 带屏蔽

Illustration/尺寸

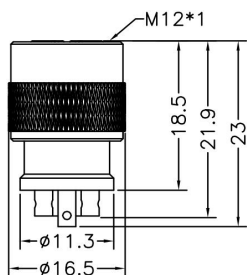

Product photo/产品图



Part number/产品料号

Pins/孔数	Code/型	Part number/产品料号
4pins/4针	T code/T型	12C064

Pin assignment front view/孔位分布前视图

T code 4pins
T型4孔



General data/常规数据

Pins Numbers/孔数	4pins/4针
Rated voltage/额定电压	630V
Rated current(40°C)/额定电流	12A
Standards/标准	IEC 61076-2-101
Termination/焊接方式	solder/焊接
Degree of protection/防护等级	IP67, IP68, IP69K
Wire gauge(mm²)/线规(平方数)	0.14mm²-0.75mm²
Wire gauge(AWG)/线号(平方数)	26AWG-18AWG
Mechanical operation/插拔次数	>100 mating cycles/大于100次
Ambient temperature (operation)/操作温度	-25°C~+85°C
Contact resistance/接触电阻	≤5mΩ
Insulation resistance/绝缘电阻	≥100MΩ
Connector body/胶芯	TPU
Pins/端子	Phosphorus copper with gold plated/磷铜镀金
Screw/螺丝	Brass with nickel plated/黄铜镀镍
Gasket/胶圈	Fluorine ring/氟胶圈
Environmental compliance/环境符合标准	RoHs, Reach

M12 T code male straight front panel mount connector, unshielded, insert/M12, T型公头直头前锁面板板端, 不带屏蔽

Illustration/尺寸

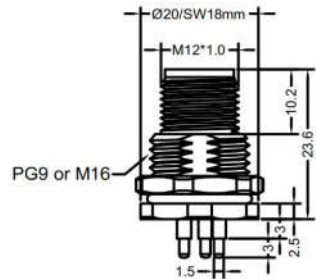

Product photo/产品图



Part number/产品料号

Pins/针数	Code/型	Part number/产品料号	
		PG9 thread 15.3±0.1/PG9螺纹15.3±0.1	M16 thread 16±0.1/M16螺纹16±0.1
4pins/4针	T code/T型	12B231	12B099

Pin assignment front view/针位分布前视图

T code 4pins
T型4针



General data/常规数据

Pins Numbers/针数	4pins/4针
Rated voltage/额定电压	630V
Rated current(40°C)/额定电流	12A
Standards/标准	IEC 61076-2-101
Termination/焊接方式	solder PCB/PCB焊接
Connector locking system/锁紧方式	Screw/螺锁
Degree of protection/防护等级	IP67, IP68, IP69K
Mechanical operation/插拔次数	>100 mating cycles/大于100次
Ambient temperature (operation)/操作温度	-25°C~+85°C
Contact resistance/接触电阻	≤5mΩ
Insulation resistance/绝缘电阻	≥100MΩ
Connector body/胶芯	TPU
Pins/端子	Brass with gold plated/黄铜镀金
Screw/螺丝	Brass with nickel plated/黄铜镀镍
Gasket/胶圈	Fluorine ring/氟胶圈
Environmental compliance/环境符合标准	RoHs, Reach

M12 T code female straight front panel mount connector, unshielded, insert/M12, T型母头直头前锁面板板端, 不带屏蔽

Illustration/尺寸

Product photo/产品图

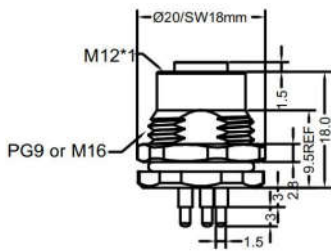

Part number/产品料号

Pins/孔数	Code/型	Part number/产品料号	
		PG9 thread 15.3±0.1/PG9螺纹15.3±0.1	M16 thread 16±0.1/M16螺纹16±0.1
4pins/4针	T code/T型	12B233	12B101

Pin assignment front view/孔位分布前视图

T code 4pins
T型4孔

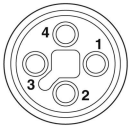

General data/常规数据

Pins Numbers/孔数	4pins/4针
Rated voltage/额定电压	630V
Rated current(40°C)/额定电流	12A
Standards/标准	IEC 61076-2-101
Termination/焊接方式	solder PCB/PCB焊接
Connector locking system/锁紧方式	Screw/螺锁
Degree of protection/防护等级	IP67, IP68, IP69K
Mechanical operation/插拔次数	>100 mating cycles/大于100次
Ambient temperature (operation)/操作温度	-25°C~+85°C
Contact resistance/接触电阻	≤5mΩ
Insulation resistance/绝缘电阻	≥100MΩ
Connector body material/胶芯材料	TPU
Pins material/端子材料	Phosphorus copper with gold plated/磷铜镀金
Screw/螺丝材料	Brass with nickel plated/黄铜镀镍
Gasket material/胶圈材料	Fluorine ring/氟胶圈
Environmental compliance/环境符合标准	RoHS, Reach

M12 T code male straight rear panel mount connector, unshielded, insert/M12, T型公头直头后锁面板板端, 不带屏蔽

Illustration/尺寸

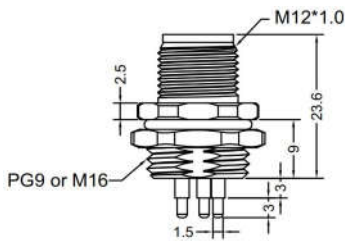

Product photo/产品图



Part number/产品料号

Pins/针数	Code/型	Part number/产品料号	
		PG9 thread 15.3±0.1/PG9螺纹15.3±0.1	M16 thread 16±0.1/M16螺纹16±0.1
4pins/4针	T code/T型	12B232	12B100

Pin assignment front view/针位分布前视图

T code 4pins
T型4针



General data/常规数据

Pins Numbers/针数	4pins/4针
Rated voltage/额定电压	630V
Rated current(40°C)/额定电流	12A
Standards/标准	IEC 61076-2-101
Termination/焊接方式	solder PCB/PCB焊接
Connector locking system/锁紧方式	Screw/螺锁
Degree of protection/防护等级	IP67, IP68, IP69K
Mechanical operation/插拔次数	>100 mating cycles/大于100次
Ambient temperature (operation)/操作温度	-25°C~+85°C
Contact resistance/接触电阻	≤5mΩ
Insulation resistance/绝缘电阻	≥100MΩ
Connector body/胶芯	TPU
Pins/端子	Brass with gold plated/黄铜镀金
Screw/螺丝材料	Brass with nickel plated/黄铜镀镍
Gasket/胶圈	Fluorine ring/氟胶圈
Environmental compliance/环境符合标准	RoHs, Reach

M12 T code female straight rear panel mount connector, unshielded, insert/M12, T型母头直头后锁面板板端, 不带屏蔽

Illustration/尺寸

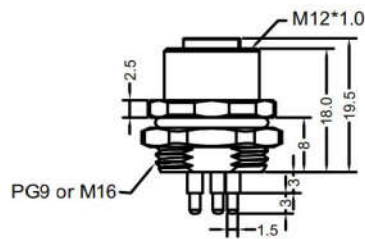

Product photo/产品图



Part number/产品料号

Pins/孔数	Code/型	Part number/产品料号	
		PG9 thread 15.3±0.1/PG9螺纹15.3±0.1	M16 thread 16±0.1/M16螺纹16±0.1
4pins/4针	T code/T型	12B234	12B102

Pin assignment front view/孔位分布前视图

T code 4pins
T型4孔

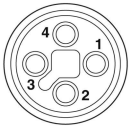

General data/常规数据

Pins Numbers/孔数	4pins/4针
Rated voltage/额定电压	630V
Rated current(40°C)/额定电流	12A
Standards/标准	IEC 61076-2-101
Termination/焊接方式	solder PCB/PCB焊接
Connector locking system/锁紧方式	Screw/螺锁
Degree of protection/防护等级	IP67, IP68, IP69K
Mechanical operation/插拔次数	>100 mating cycles/大于100次
Ambient temperature (operation)/操作温度	-25°C~+85°C
Contact resistance/接触电阻	≤5mΩ
Insulation resistance/绝缘电阻	≥100MΩ
Connector body/胶芯	TPU
Pins/端子	Phosphorus copper with gold plated/磷铜镀金
Screw/螺丝	Brass with nickel plated/黄铜镀镍
Gasket/胶圈	Fluorine ring/氟胶圈
Environmental compliance/环境符合标准	RoHs, Reach

M12 T code male straight front panel mount connector, unshielded, solder/M12, T型公头直头前锁面板焊线式, 不带屏蔽

Illustration/尺寸

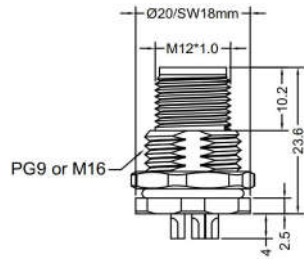

Product photo/产品图



Part number/产品料号

Pins/针数	Code/型	Part number("X" is length millimetre mm)/产品料号("X"表示长度, 单位毫米mm)	
		PG9 thread 15.3±0.1/PG9螺纹15.3±0.1	M16 thread 16±0.1/M16螺纹16±0.1
4pins/4针	T code/T型	12H214	12H220

Pin assignment front view/针位分布前视图

T code 4pins
T型4针



General data/常规数据

Pins Numbers/针数	4pins/4针
Rated voltage/额定电压	630V
Rated current(40°C)/额定电流	12A
Standards/标准	IEC 61076-2-101
Termination/焊接方式	solder/焊接
Connector locking system/锁紧方式	Screw/螺锁
Degree of protection/防护等级	IP67, IP68, IP69K
Wire gauge(mm²)/线规(平方数)	0.14mm²-0.75mm²
Wire gauge(AWG)/线号(平方数)	26AWG-18AWG
Mechanical operation/插拔次数	>100 mating cycles/大于100次
Ambient temperature (operation)/操作温度	-40°C~+85°C
Contact resistance/接触电阻	≤5mΩ
Insulation resistance/绝缘电阻	≥100MΩ
Connector body/胶芯	TPU
Pins/端子	Brass with gold plated/黄铜镀金
Screw/螺丝	Brass with nickel plated/黄铜镀镍
Gasket/胶圈	Fluorine ring/氟胶圈
Environmental compliance/环境符合标准	RoHs, Reach

M12 T code female straight front panel mount connector, unshielded, solder/M12, T型母头直头前锁面板焊线式, 不带屏蔽

Illustration/尺寸

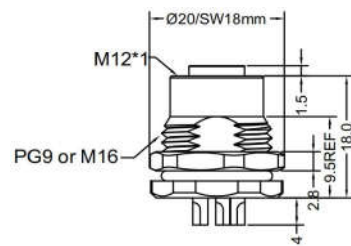

Product photo/产品图



Part number/产品料号

Pins/孔数	Code/型	Part number("X" is length millimetre mm)/产品料号("X"表示长度, 单位毫米mm)	
		PG9 thread 15.3±0.1/PG9螺纹15.3±0.1	M16 thread 16±0.1/M16螺纹16±0.1
4pins/4针	T code/T型	12H216	12H218

Pin assignment front view/孔位分布前视图

T code 4pins
T型4孔

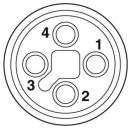

General data/常规数据

Pins Numbers/孔数	4pins/4针
Rated voltage/额定电压	630V
Rated current(40°C)/额定电流	12A
Standards/标准	IEC 61076-2-101
Termination/焊接方式	solder/焊接
Connector locking system/锁紧方式	Screw/螺锁
Degree of protection/防护等级	IP67, IP68, IP69K
Wire gauge(mm²)/线规(平方数)	0.14mm²-0.75mm²
Wire gauge(AWG)/线号(平方数)	26AWG-18AWG
Mechanical operation/插拔次数	>100 mating cycles/大于100次
Ambient temperature (operation)/操作温度	-40°C~+85°C
Contact resistance/接触电阻	≤5mΩ
Insulation resistance/绝缘电阻	≥100MΩ
Connector body/胶芯	TPU
Pins/端子	Phosphorus copper with gold plated/磷铜镀金
Screw/螺丝	Brass with nickel plated/黄铜镀镍
Gasket/胶圈	Fluorine ring/氟胶圈
Environmental compliance/环境符合标准	RoHs, Reach

M12 T code male straight rear panel mount connector, unshielded, solder/M12, T型公头直头后锁面板焊线式, 不带屏蔽

Illustration/尺寸

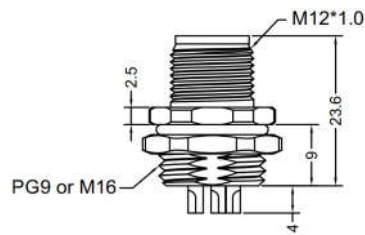

Product photo/产品图



Part number/产品料号

Pins/针数	Code/型	Part number("X" is length millimetre mm)/产品料号("X"表示长度, 单位毫米mm)	
4pins/4针	T code/T型	PG9 thread 15.3±0.1/PG9螺纹15.3±0.1	M16 thread 16±0.1/M16螺纹16±0.1
		12H215	12H221

Pin assignment front view/针位分布前视图

T code 4pins
T型4针



General data/常规数据

Pins Numbers/针数	4pins/4针
Rated voltage/额定电压	630V
Rated current(40°C)/额定电流	12A
Standards/标准	IEC 61076-2-101
Termination/焊接方式	solder/焊接
Connector locking system/锁紧方式	Screw/螺锁
Degree of protection/防护等级	IP67, IP68, IP69K
Wire gauge(mm²)/线规(平方数)	0.14mm²-0.75mm²
Wire gauge(AWG)/线号(平方数)	26AWG-18AWG
Mechanical operation/插拔次数	>100 mating cycles/大于100次
Ambient temperature (operation)/操作温度	-40°C~+85°C
Contact resistance/接触电阻	≤5mΩ
Insulation resistance/绝缘电阻	≥100MΩ
Connector body/胶芯	TPU
Pins/端子	Brass with gold plated/黄铜镀金
Screw/螺丝	Brass with nickel plated/黄铜镀镍
Gasket/胶圈	Fluorine ring/氟胶圈
Environmental compliance/环境符合标准	RoHs, Reach

M12 T code female straight rear panel mount connector, unshielded, solder/M12, T型母头直头后锁面板焊线式, 不带屏蔽

Illustration/尺寸

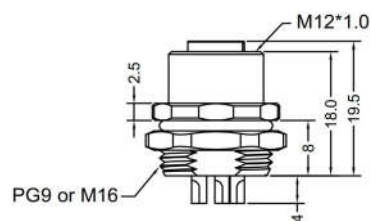

Product photo/产品图



Part number/产品料号

Pins/孔数	Code/型	Part number("X" is length millimetre mm)/产品料号("X"表示长度, 单位毫米mm)	
4pins/4针	T code/T型	PG9 thread 15.3±0.1/PG9螺纹15.3±0.1	M16 thread 16±0.1/M16螺纹16±0.1
		12H217	12H219

Pin assignment front view/孔位分布前视图

T code 4pins
T型4孔

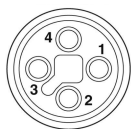

General data/常规数据

Pins Numbers/孔数	4pins/4针
Rated voltage/额定电压	630V
Rated current(40°C)/额定电流	12A
Standards/标准	IEC 61076-2-101
Termination/焊接方式	solder/焊接
Connector locking system/锁紧方式	Screw/螺锁
Degree of protection/防护等级	IP67, IP68, IP69K
Wire gauge(mm²)/线规(平方数)	0.14mm²-0.75mm²
Wire gauge(AWG)/线号(平方数)	26AWG-18AWG
Mechanical operation/插拔次数	>100 mating cycles/大于100次
Ambient temperature (operation)/操作温度	-40°C~+85°C
Contact resistance/接触电阻	≤5mΩ
Insulation resistance/绝缘电阻	≥100MΩ
Connector body/胶芯	TPU
Pins/端子	Phosphorus copper with gold plated/磷铜镀金
Screw/螺丝	Brass with nickel plated/黄铜镀镍
Gasket/胶圈	Fluorine ring/氟胶圈
Environmental compliance/环境符合标准	RoHs, Reach

M12 T code male straight front panel mount connector, unshielded, single wires/M12, T型公头直头前锁面板带线, 不带屏蔽

Illustration/尺寸

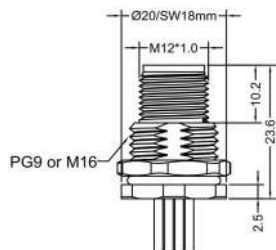

Product photo/产品图



Part number/产品料号

Pins/针数	Code/型	Part number("X" is length millimetre mm)/产品料号("X"表示长度, 单位毫米mm)	
		PG9 thread 15.3±0.1/PG9螺纹15.3±0.1	M16 thread 16±0.1/M16螺纹16±0.1
4pins/4针	T code/T型	12D473	12D131

Pin assignment front view/针位分布前视图

T code 4pins
T型4针

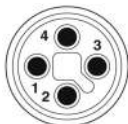

General data/常规数据

Pins Numbers/针数	4pins/4针
Rated voltage/额定电压	630V
Rated current(40°C)/额定电流	12A
Standards/标准	IEC 61076-2-101
Termination/焊接方式	solder/焊接
Connector locking system/锁紧方式	Screw/螺锁
Degree of protection/防护等级	IP67, IP68, IP69K
Wire gauge(mm²)/线规(平方数)	0.14mm²-0.75mm²
Wire gauge(AWG)/线号(平方数)	26AWG-18AWG
Mechanical operation/插拔次数	>100 mating cycles/大于100次
Ambient temperature (operation)/操作温度	-40°C~+85°C
Contact resistance/接触电阻	≤5mΩ
Insulation resistance/绝缘电阻	≥100MΩ
Connector body/胶芯	TPU
Pins/端子	Brass with gold plated/黄铜镀金
Screw/螺丝	Brass with nickel plated/黄铜镀镍
Gasket/胶圈	Fluorine ring/氟胶圈
Environmental compliance/环境符合标准	RoHs, Reach

M12 T code female straight front panel mount connector, unshielded, single wires/M12, T型母头直头前板带线, 不带屏蔽

Illustration/尺寸

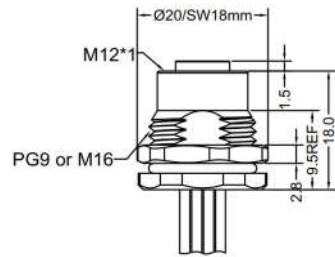

Product photo/产品图



Part number/产品料号

Pins/孔数	Code/型	Part number("X" is length millimetre mm)/产品料号("X"表示长度, 单位毫米mm)	
4pins/4针	T code/T型	PG9 thread 15.3±0.1/PG9螺纹15.3±0.1	M16 thread 16±0.1/M16螺纹16±0.1
		12D475	12D133

Pin assignment front view/孔位分布前视图

T code 4pins
T型4孔



General data/常规数据

Pins Numbers/孔数	4pins/4针
Rated voltage/额定电压	630V
Rated current(40°C)/额定电流	12A
Standards/标准	IEC 61076-2-101
Termination/焊接方式	solder/焊接
Connector locking system/锁紧方式	Screw/螺锁
Degree of protection/防护等级	IP67, IP68, IP69K
Wire gauge(mm²)/线规(平方数)	0.14mm²-0.75mm²
Wire gauge(AWG)/线号(平方数)	26AWG-18AWG
Mechanical operation/插拔次数	>100 mating cycles/大于100次
Ambient temperature (operation)/操作温度	-40°C~+85°C
Contact resistance/接触电阻	≤5mΩ
Insulation resistance/绝缘电阻	≥100MΩ
Connector body/胶芯	TPU
Pins/端子	Phosphorus copper with gold plated/磷铜镀金
Screw/螺丝	Brass with nickel plated/黄铜镀镍
Gasket/胶圈	Fluorine ring/氟胶圈
Environmental compliance/环境符合标准	RoHs, Reach

M12 T code male straight rear panel mount connector, unshielded, single wires/M12, T型公头直头后锁面板带线, 不带屏蔽

Illustration/尺寸

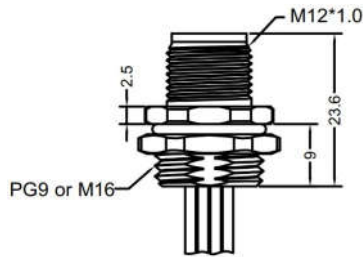

Product photo/产品图



Part number/产品料号

Pins/针数	Code/型	Part number("X" is length millimetre mm)/产品料号("X"表示长度, 单位毫米mm)	
		PG9 thread 15.3±0.1/PG9螺纹15.3±0.1	M16 thread 16±0.1/M16螺纹16±0.1
4pins/4针	T code/T型	12D474	12D132

Pin assignment front view/针位分布前视图

T code 4pins
T型4针



General data/常规数据

Pins Numbers/针数	4pins/4针
Rated voltage/额定电压	630V
Rated current(40°C)/额定电流	12A
Standards/标准	IEC 61076-2-101
Termination/焊接方式	solder/焊接
Connector locking system/锁紧方式	Screw/螺锁
Degree of protection/防护等级	IP67, IP68, IP69K
Wire gauge(mm²)/线规(平方数)	0.14mm²-0.75mm²
Wire gauge(AWG)/线号(平方数)	26AWG-18AWG
Mechanical operation/插拔次数	>100 mating cycles/大于100次
Ambient temperature (operation)/操作温度	-40°C~+85°C
Contact resistance/接触电阻	≤5mΩ
Insulation resistance/绝缘电阻	≥100MΩ
Connector body/胶芯	TPU
Pins/端子	Brass with gold plated/黄铜镀金
Screw/螺丝	Brass with nickel plated/黄铜镀镍
Gasket/胶圈	Fluorine ring/氟胶圈
Environmental compliance/环境符合标准	RoHs, Reach

M12 T code female straight rear panel mount connector, unshielded, single wires/M12, T型母头直头后锁面板带线, 不带屏蔽

Illustration/尺寸

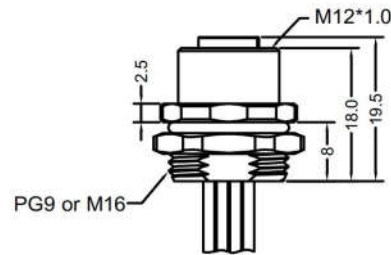

Product photo/产品图



Part number/产品料号

Pins/孔数	Code/型	Part number("X" is length millimetre mm)/产品料号("X"表示长度, 单位毫米mm)	
		PG9 thread 15.3±0.1/PG9螺纹15.3±0.1	M16 thread 16±0.1/M16螺纹16±0.1
4pins/4针	T code/T型	12D476	12D134

Pin assignment front view/孔位分布前视图

T code 4pins
T型4孔

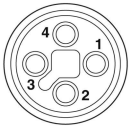

General data/常规数据

Pins Numbers/孔数	4pins/4针
Rated voltage/额定电压	630V
Rated current(40°C)/额定电流	12A
Standards/标准	IEC 61076-2-101
Termination/焊接方式	solder/焊接
Connector locking system/锁紧方式	Screw/螺锁
Degree of protection/防护等级	IP67, IP68, IP69K
Wire gauge(mm²)/线规(平方数)	0.14mm²-0.75mm²
Wire gauge(AWG)/线号(平方数)	26AWG-18AWG
Mechanical operation/插拔次数	>100 mating cycles/大于100次
Ambient temperature (operation)/操作温度	-40°C~+85°C
Contact resistance/接触电阻	≤5mΩ
Insulation resistance/绝缘电阻	≥100MΩ
Connector body/胶芯	TPU
Pins/端子	Phosphorus copper with gold plated/磷铜镀金
Screw/螺丝	Brass with nickel plated/黄铜镀镍
Gasket/胶圈	Fluorine ring/氟胶圈
Environmental compliance/环境符合标准	RoHs, Reach

M12 T code male straight molded cable, unshielded/M12, T型公头直头成型式连接线, 不带屏蔽

Illustration/尺寸

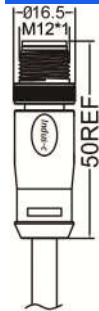

Product photo/产品图



Part number/产品料号

Pins/针数	Code/型	Part number("X" is length millimetre mm)/产品料号("X"表示长度, 单位毫米mm)	
		PVC jacket/PVC外被	PUR jacket/PUR外被
4pins/4针	T code/T型	-40°C~+105°C	-40°C~+105°C
		12L01681-X	12L01685-X

Pin assignment front view/针位分布前视图

T code 4pins
T型4针



General data/常规数据

Pins Numbers/针数	4pins/4针
Rated voltage/额定电压	630V
Rated current(40°C)/额定电流	12A
Standards/标准	IEC 61076-2-101
Termination/焊接方式	solder and over-mold/焊接和成型
Degree of protection/防护等级	IP67, IP68, IP69K
Wire gauge(mm²)/线规(平方数)	0.14mm²-0.75mm²
Wire gauge(AWG)/线号(平方数)	26AWG-18AWG
Mechanical operation/插拔次数	>100 mating cycles/大于100次
Contact resistance/接触电阻	≤5mΩ
Insulation resistance/绝缘电阻	≥100MΩ
Connector body/胶芯	TPU
Pins/端子	Brass with gold plated/黄铜镀金
Screw/螺丝	Brass with nickel plated/黄铜镀镍
Environmental compliance/环境符合标准	RoHs, Reach

M12 T code female straight molded cable, unshielded/M12, T型母头直头成型式连接线, 不带屏蔽

Illustration/尺寸

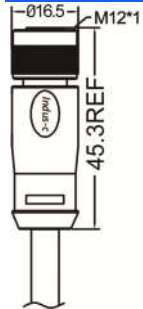

Product photo/产品图



Part number/产品料号

Pins/孔数	Code/型	Part number("X" is length millimetre mm)/产品料号("X"表示长度, 单位毫米mm)	
		PVC jacket/PVC外被	PUR jacket/PUR外被
4pins/4针	T code/T型	-40°C~+105°C	-40°C~+105°C
		12L01682-X	12L01686-X

Pin assignment front view/孔位分布前视图

T code 4pins
T型4孔

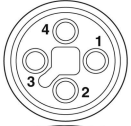

General data/常规数据

Pins Numbers/孔数	4pins/4针
Rated voltage/额定电压	630V
Rated current(40°C)/额定电流	12A
Standards/标准	IEC 61076-2-101
Termination/焊接方式	solder and over-mold/焊接和成型
Degree of protection/防护等级	IP67, IP68, IP69K
Wire gauge(mm²)/线规(平方数)	0.14mm²-0.75mm²
Wire gauge(AWG)/线号(平方数)	26AWG-18AWG
Mechanical operation/插拔次数	>100 mating cycles/大于100次
Contact resistance/接触电阻	≤5mΩ
Insulation resistance/绝缘电阻	≥100MΩ
Connector body/胶芯	TPU
Pins/端子	Phosphorus copper with gold plated/磷铜镀金
Screw/螺丝	Brass with nickel plated/黄铜镀镍
Environmental compliance/环境符合标准	RoHs, Reach

M12 T code male straight molded cable, shielded/M12, T型公头直头成型式连接线, 带屏蔽

Illustration/尺寸

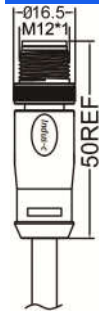

Product photo/产品图



Part number/产品料号

Pins/针数	Code/型	Part number("X" is length millimetre mm)/产品料号("X"表示长度, 单位毫米mm)	
		PVC jacket/PVC外被	PUR jacket/PUR外被
4pins/4针	T code/T型	-40°C~+105°C	-40°C~+105°C
		12L01689-X	12L01693-X

Pin assignment front view/针位分布前视图

T code 4pins
T型4针



General data/常规数据

Pins Numbers/针数	4pins/4针
Rated voltage/额定电压	630V
Rated current(40°C)/额定电流	12A
Standards/标准	IEC 61076-2-101
Termination/焊接方式	solder and over-mold/焊接和成型
Degree of protection/防护等级	IP67, IP68, IP69K
Wire gauge(mm²)/线规(平方数)	0.14mm²-0.75mm²
Wire gauge(AWG)/线号(平方数)	26AWG-18AWG
Mechanical operation/插拔次数	>100 mating cycles/大于100次
Contact resistance/接触电阻	≤5mΩ
Insulation resistance/绝缘电阻	≥100MΩ
Connector body/胶芯	TPU
Pins/端子	Brass with gold plated/黄铜镀金
Screw/螺丝	Brass with nickel plated/黄铜镀镍
Environmental compliance/环境符合标准	RoHs, Reach

M12 T code female straight molded cable, shielded/M12, T型母头直头成型式连接线, 带屏蔽

Illustration/尺寸

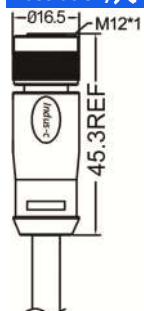

Product photo/产品图



Part number/产品料号

Pins/孔数	Code/型	Part number("X" is length millimetre mm)/产品料号("X"表示长度, 单位毫米mm)	
		PVC jacket/PVC外被	PUR jacket/PUR外被
4pins/4针	T code/T型	-40°C~+105°C	-40°C~+105°C
		12L01690-X	12L01694-X

Pin assignment front view/孔位分布前视图

T code 4pins
T型4孔



General data/常规数据

Pins Numbers/孔数	4pins/4针
Rated voltage/额定电压	630V
Rated current(40°C)/额定电流	12A
Standards/标准	IEC 61076-2-101
Termination/焊接方式	solder and over-mold/焊接和成型
Degree of protection/防护等级	IP67, IP68, IP69K
Wire gauge(mm²)/线规(平方数)	0.14mm²-0.75mm²
Wire gauge(AWG)/线号(平方数)	26AWG-18AWG
Mechanical operation/插拔次数	>100 mating cycles/大于100次
Contact resistance/接触电阻	≤5mΩ
Insulation resistance/绝缘电阻	≥100MΩ
Connector body/胶芯	TPU
Pins/端子	Phosphorus copper with gold plated/磷铜镀金
Screw/螺丝	Brass with nickel plated/黄铜镀镍
Environmental compliance/环境符合标准	RoHs, Reach

M12 T code male right angle molded cable, unshielded/M12, T型公头弯头成型式连接线, 不带屏蔽

Illustration/尺寸

Product photo/产品图

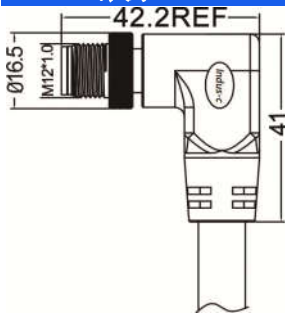

Part number/产品料号

Pins/针数	Code/型	Part number("X" is length millimetre mm)/产品料号("X"表示长度, 单位毫米mm)	
		PVC jacket/PVC外被	PUR jacket/PUR外被
4pins/4针	T code/T型	-40°C~+105°C	-40°C~+105°C
		12L01683-X	12L01687-X

Pin assignment front view/针位分布前视图

T code 4pins
T型4针



General data/常规数据

Pins Numbers/针数	4pins/4针
Rated voltage/额定电压	630V
Rated current(40°C)/额定电流	12A
Standards/标准	IEC 61076-2-101
Termination/焊接方式	solder and over-mold/焊接和成型
Degree of protection/防护等级	IP67, IP68, IP69K
Wire gauge(mm²)/线规(平方数)	0.14mm²-0.75mm²
Wire gauge(AWG)/线号(平方数)	26AWG-18AWG
Mechanical operation/插拔次数	>100 mating cycles/大于100次
Contact resistance/接触电阻	≤5mΩ
Insulation resistance/绝缘电阻	≥100MΩ
Connector body/胶芯	TPU
Pins/端子	Brass with gold plated/黄铜镀金
Screw/螺丝	Brass with nickel plated/黄铜镀镍
Environmental compliance/环境符合标准	RoHs, Reach

M12 T code female right angle molded cable, unshielded/M12, T型母头弯头成型式连接线, 不带屏蔽

Illustration/尺寸

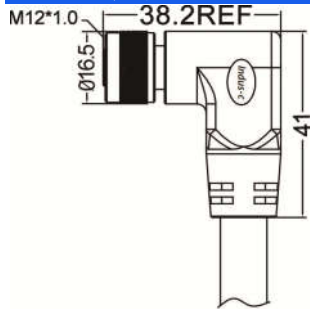

Product photo/产品图



Part number/产品料号

Pins/孔数	Code/型	Part number("X" is length millimetre mm)/产品料号("X"表示长度, 单位毫米mm)	
		PVC jacket/PVC外被	PUR jacket/PUR外被
4pins/4针	T code/T型	-40°C~+105°C	-40°C~+105°C
		12L01684-X	12L01688-X

Pin assignment front view/孔位分布前视图

T code 4pins
T型4孔

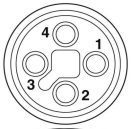

General data/常规数据

Pins Numbers/孔数	4pins/4针
Rated voltage/额定电压	630V
Rated current(40°C)/额定电流	12A
Standards/标准	IEC 61076-2-101
Termination/焊接方式	solder and over-mold/焊接和成型
Degree of protection/防护等级	IP67, IP68, IP69K
Wire gauge(mm²)/线规(平方数)	0.14mm²-0.75mm²
Wire gauge(AWG)/线号(平方数)	26AWG-18AWG
Mechanical operation/插拔次数	>100 mating cycles/大于100次
Contact resistance/接触电阻	≤5mΩ
Insulation resistance/绝缘电阻	≥100MΩ
Connector body/胶芯	TPU
Pins/端子	Phosphorus copper with gold plated/磷铜镀金
Screw/螺丝	Brass with nickel plated/黄铜镀镍
Environmental compliance/环境符合标准	RoHs, Reach

M12 T code male right angle molded cable, shielded/M12, T型公头弯头成型式连接线, 带屏蔽

Illustration/尺寸

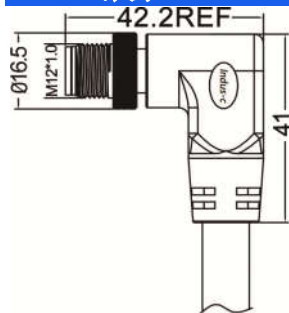

Product photo/产品图



Part number/产品料号

Pins/针数	Code/型	Part number("X" is length millimetre mm)/产品料号("X"表示长度, 单位毫米mm)	
		PVC jacket/PVC外被	PUR jacket/PUR外被
4pins/4针	T code/T型	-40°C~+105°C	-40°C~+105°C
		12L01691-X	12L01695-X

Pin assignment front view/针位分布前视图

T code 4pins
T型4针



General data/常规数据

Pins Numbers/针数	4pins/4针
Rated voltage/额定电压	630V
Rated current(40°C)/额定电流	12A
Standards/标准	IEC 61076-2-101
Termination/焊接方式	solder and over-mold/焊接和成型
Degree of protection/防护等级	IP67, IP68, IP69K
Wire gauge(mm²)/线规(平方数)	0.14mm²-0.75mm²
Wire gauge(AWG)/线号(平方数)	26AWG-18AWG
Mechanical operation/插拔次数	>100 mating cycles/大于100次
Contact resistance/接触电阻	≤5mΩ
Insulation resistance/绝缘电阻	≥100MΩ
Connector body/胶芯	TPU
Pins/端子	Brass with gold plated/黄铜镀金
Screw/螺丝	Brass with nickel plated/黄铜镀镍
Environmental compliance/环境符合标准	RoHs, Reach

M12 T code female right angle molded cable, shielded/M12, T型母头弯头成型式连接线, 带屏蔽

Illustration/尺寸

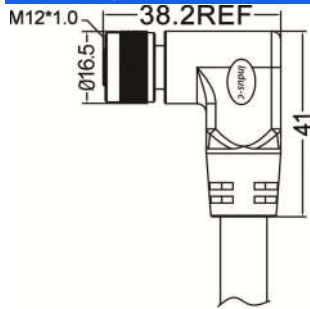

Product photo/产品图



Part number/产品料号

Pins/孔数	Code/型	Part number("X" is length millimetre mm)/产品料号("X"表示长度, 单位毫米mm)	
		PVC jacket/PVC外被	PUR jacket/PUR外被
4pins/4针	T code/T型	-40°C~+105°C	-40°C~+105°C
		12L01692-X	12L01696-X

Pin assignment front view/孔位分布前视图

T code 4pins
T型4孔

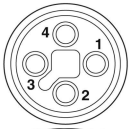

General data/常规数据

Pins Numbers/孔数	4pins/4针
Rated voltage/额定电压	630V
Rated current(40°C)/额定电流	12A
Standards/标准	IEC 61076-2-101
Termination/焊接方式	solder and over-mold/焊接和成型
Degree of protection/防护等级	IP67, IP68, IP69K
Wire gauge(mm²)/线规(平方数)	0.14mm²-0.75mm²
Wire gauge(AWG)/线号(平方数)	26AWG-18AWG
Mechanical operation/插拔次数	>100 mating cycles/大于100次
Contact resistance/接触电阻	≤5mΩ
Insulation resistance/绝缘电阻	≥100MΩ
Connector body/胶芯	TPU
Pins/端子	Phosphorus copper with gold plated/磷铜镀金
Screw/螺丝	Brass with nickel plated/黄铜镀镍
Environmental compliance/环境符合标准	RoHs, Reach

M12 T code male to male right angle molded cable, unshielded/M12, T型公头弯头对公头弯头连接线, 不带屏蔽

Illustration/尺寸

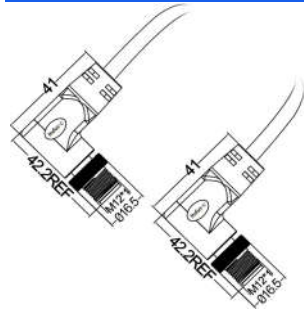

Product photo/产品图



Part number/产品料号

Pins/针数	Code/型	Part number("X" is length millimetre mm)/产品料号("X"表示长度, 单位毫米mm)	
		PVC jacket/PVC外被	PUR jacket/PUR外被
4pins/4针	T code/T型	-40°C~+105°C	-40°C~+105°C
		12L01717-X	12L01718-X

Pin assignment front view/针位分布前视图

T code 4pins
T型4针



General data/常规数据

Pins Numbers/针数	4pins/4针
Rated voltage/额定电压	630V
Rated current(40°C)/额定电流	12A
Standards/标准	IEC 61076-2-101
Termination/焊接方式	solder and over-mold/焊接和成型
Degree of protection/防护等级	IP67, IP68, IP69K
Wire gauge(mm²)/线规(平方数)	0.14mm²-0.75mm²
Wire gauge(AWG)/线号(平方数)	26AWG-18AWG
Mechanical operation/插拔次数	>100 mating cycles/大于100次
Contact resistance/接触电阻	≤5mΩ
Insulation resistance/绝缘电阻	≥100MΩ
Connector body/胶芯	TPU
Pins/端子	Brass with gold plated/黄铜镀金
Screw/螺丝	Brass with nickel plated/黄铜镀镍
Environmental compliance/环境符合标准	RoHs, Reach

M12 T code male to female right angle molded cable, unshielded/M12, T型公头弯头对母头弯头连接线, 不带屏蔽

Illustration/尺寸

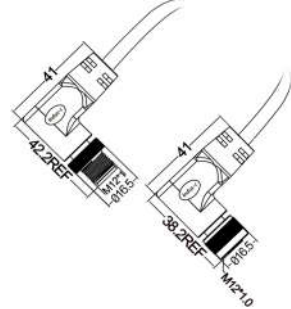

Product photo/产品图



Part number/产品料号

Pins/针数	Code/型	Part number("X" is length millimetre mm)/产品料号("X"表示长度, 单位毫米mm)	
		PVC jacket/PVC外被	PUR jacket/PUR外被
4pins/4针	T code/T型	-40°C~+105°C	-40°C~+105°C
		12L01719-X	12L01720-X

Pin assignment front view/针位分布前视图

T code 4pins
T型4针



T code 4pins
T型4孔

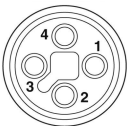

General data/常规数据

Pins Numbers/针数	4pins/4针
Rated voltage/额定电压	630V
Rated current(40°C)/额定电流	12A
Standards/标准	IEC 61076-2-101
Termination/焊接方式	solder and over-mold/焊接和成型
Degree of protection/防护等级	IP67, IP68, IP69K
Wire gauge(mm²)/线规(平方数)	0.14mm²-0.75mm²
Wire gauge(AWG)/线号(平方数)	26AWG-18AWG
Mechanical operation/插拔次数	>100 mating cycles/大于100次
Contact resistance/接触电阻	≤5mΩ
Insulation resistance/绝缘电阻	≥100MΩ
Connector body/胶芯	TPU
Male pin/公端子	Brass with gold plated/黄铜镀金
Female pin/母端子	Phosphorus copper with gold plated/磷铜镀金
Screw/螺丝	Brass with nickel plated/黄铜镀镍
Over-mold/成型	TPU
Environmental compliance/环境符合标准	RoHS, Reach

M12 T code male right angle to female straight molded cable, unshielded/M12, T型公头弯头对母头直头成型式连接线, 不带屏蔽

Illustration/尺寸

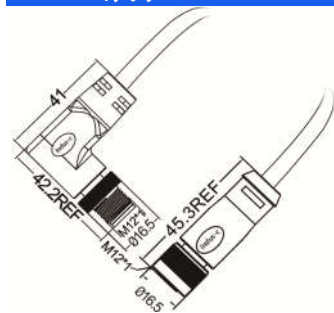

Product photo/产品图



Part number/产品料号

Pins/针数	Code/型	Part number("X" is length millimetre mm)/产品料号("X"表示长度, 单位毫米mm)	
		PVC jacket/PVC外被	PUR jacket/PUR外被
4pins/4针	T code/T型	-40°C~+105°C	-40°C~+105°C
		12L01721-X	12L01722-X

Pin assignment front view/针位分布前视图

T code 4pins
T型4针



T code 4pins
T型4孔

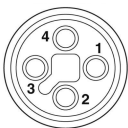

General data/常规数据

Pins Numbers/针数	4pins/4针
Rated voltage/额定电压	630V
Rated current(40°C)/额定电流	12A
Standards/标准	IEC 61076-2-101
Termination/焊接方式	solder and over-mold/焊接和成型
Degree of protection/防护等级	IP67, IP68, IP69K
Wire gauge(mm²)/线规(平方数)	0.14mm²-0.75mm²
Wire gauge(AWG)/线号(平方数)	26AWG-18AWG
Mechanical operation/插拔次数	>100 mating cycles/大于100次
Contact resistance/接触电阻	≤5mΩ
Insulation resistance/绝缘电阻	≥100MΩ
Connector body/胶芯	TPU
Male pin/公端子	Brass with gold plated/黄铜镀金
Female pin/母端子	Phosphorus copper with gold plated/磷铜镀金
Screw/螺丝	Brass with nickel plated/黄铜镀镍
Over-mold/成型	TPU
Environmental compliance/环境符合标准	RoHS, Reach

M12 T code male straight to male right angle molded cable, unshielded/M12, T型公头直头对公头弯头连接线, 不带屏蔽

Illustration/尺寸

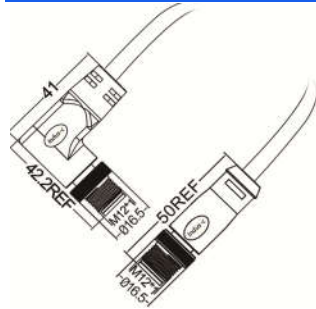

Product photo/产品图



Part number/产品料号

Pins/针数	Code/型	Part number("X" is length millimetre mm)/产品料号("X"表示长度, 单位毫米mm)	
		PVC jacket/PVC外被	PUR jacket/PUR外被
4pins/4针	T code/T型	-40°C~+105°C	-40°C~+105°C
		12L01723-X	12L01724-X

Pin assignment front view/针位分布前视图

T code 4pins
T型4针



General data/常规数据

Pins Numbers/针数	4pins/4针
Rated voltage/额定电压	630V
Rated current(40°C)/额定电流	12A
Standards/标准	IEC 61076-2-101
Termination/焊接方式	solder and over-mold/焊接和成型
Degree of protection/防护等级	IP67, IP68, IP69K
Wire gauge(mm²)/线规(平方数)	0.14mm²-0.75mm²
Wire gauge(AWG)/线号(平方数)	26AWG-18AWG
Mechanical operation/插拔次数	>100 mating cycles/大于100次
Contact resistance/接触电阻	≤5mΩ
Insulation resistance/绝缘电阻	≥100MΩ
Connector body/胶芯	TPU
Pins/端子	Brass with gold plated/黄铜镀金
Screw/螺丝	Brass with nickel plated/黄铜镀镍
Environmental compliance/环境符合标准	RoHs, Reach

M12 T code male to male straight molded cable, unshielded/M12, T型公头直头对公头直头连接线, 不带屏蔽

Illustration/尺寸

Product photo/产品图



Part number/产品料号

Pins/针数	Code/型	Part number("X" is length millimetre mm)/产品料号("X"表示长度, 单位毫米mm)	
		PVC jacket/PVC外被	PUR jacket/PUR外被
4pins/4针	T code/T型	-40°C~+105°C	-40°C~+105°C
		12L01725-X	12L01726-X

Pin assignment front view/针位分布前视图

T code 4pins
T型4针



General data/常规数据

Pins Numbers/针数	4pins/4针
Rated voltage/额定电压	630V
Rated current(40°C)/额定电流	12A
Standards/标准	IEC 61076-2-101
Termination/焊接方式	solder and over-mold/焊接和成型
Degree of protection/防护等级	IP67, IP68, IP69K
Wire gauge(mm²)/线规(平方数)	0.14mm²-0.75mm²
Wire gauge(AWG)/线号(平方数)	26AWG-18AWG
Mechanical operation/插拔次数	>100 mating cycles/大于100次
Contact resistance/接触电阻	≤5mΩ
Insulation resistance/绝缘电阻	≥100MΩ
Connector body/胶芯	TPU
Pins/端子	Brass with gold plated/黄铜镀金
Screw/螺丝	Brass with nickel plated/黄铜镀镍
Environmental compliance/环境符合标准	RoHs, Reach

M12 T code male straight to female right angle molded cable, unshielded/M12, T型公头直头对母头弯头连接线, 不带屏蔽

Illustration/尺寸

Product photo/产品图

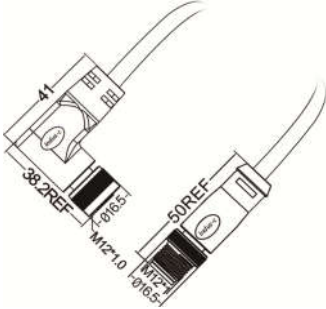

Part number/产品料号

Pins/针数	Code/型	Part number("X" is length millimetre mm)/产品料号("X"表示长度, 单位毫米mm)	
		PVC jacket/PVC外被 -40°C~+105°C	PUR jacket/PUR外被 -40°C~+105°C
4pins/4针	T code/T型	12L01727-X	12L01728-X

Pin assignment front view/针位分布前视图

T code 4pins
T型4针



T code 4pins
T型4孔

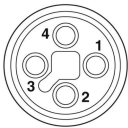

General data/常规数据

Pins Numbers/针数	4pins/4针
Rated voltage/额定电压	630V
Rated current(40°C)/额定电流	12A
Standards/标准	IEC 61076-2-101
Termination/焊接方式	solder and over-mold/焊接和成型
Degree of protection/防护等级	IP67, IP68, IP69K
Wire gauge(mm²)/线规(平方数)	0.14mm²-0.75mm²
Wire gauge(AWG)/线号(平方数)	26AWG-18AWG
Mechanical operation/插拔次数	>100 mating cycles/大于100次
Contact resistance/接触电阻	≤5mΩ
Insulation resistance/绝缘电阻	≥100MΩ
Connector body/胶芯	TPU
Male pin/公端子	Brass with gold plated/黄铜镀金
Female pin/母端子	Phosphorus copper with gold plated/磷铜镀金
Screw/螺丝	Brass with nickel plated/黄铜镀镍
Over-mold/成型	TPU
Environmental compliance/环境符合标准	RoHS, Reach

M12 T code male to female straight molded cable, unshielded/M12, T型公头直头对母头直头连接线, 不带屏蔽

Illustration/尺寸

Product photo/产品图

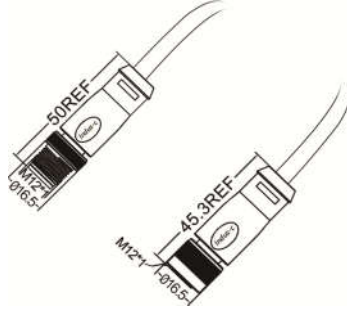

Part number/产品料号

Pins/针数	Code/型	Part number("X" is length millimetre mm)/产品料号("X"表示长度, 单位毫米mm)	
		PVC jacket/PVC外被	PUR jacket/PUR外被
4pins/4针	T code/T型	-40°C~+105°C	-40°C~+105°C
		12L01729-X	12L01730-X

Pin assignment front view/针位分布前视图

T code 4pins
T型4针



T code 4pins
T型4孔

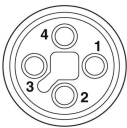

General data/常规数据

Pins Numbers/针数	4pins/4针
Rated voltage/额定电压	630V
Rated current(40°C)/额定电流	12A
Standards/标准	IEC 61076-2-101
Termination/焊接方式	solder and over-mold/焊接和成型
Degree of protection/防护等级	IP67, IP68, IP69K
Wire gauge(mm²)/线规(平方数)	0.14mm²-0.75mm²
Wire gauge(AWG)/线号(平方数)	26AWG-18AWG
Mechanical operation/插拔次数	>100 mating cycles/大于100次
Contact resistance/接触电阻	≤5mΩ
Insulation resistance/绝缘电阻	≥100MΩ
Connector body/胶芯	TPU
Male pin/公端子	Brass with gold plated/黄铜镀金
Female pin/母端子	Phosphorus copper with gold plated/磷铜镀金
Screw/螺丝	Brass with nickel plated/黄铜镀镍
Over-mold/成型	TPU
Environmental compliance/环境符合标准	RoHS, Reach

M12 T code female to female right angle molded cable, unshielded/M12, T型母头弯头对母头弯头连接线, 不带屏蔽

Illustration/尺寸

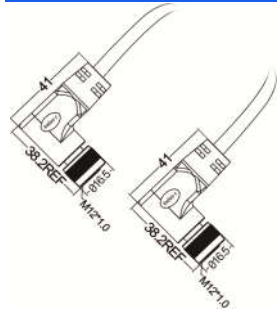

Product photo/产品图



Part number/产品料号

Pins/孔数	Code/型	Part number("X" is length millimetre mm)/产品料号("X"表示长度, 单位毫米mm)	
		PVC jacket/PVC外被	PUR jacket/PUR外被
4pins/4针	T code/T型	-40°C~+105°C	-40°C~+105°C
		12L01731-X	12L01732-X

Pin assignment front view/孔位分布前视图

T code 4pins
T型4孔

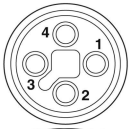

General data/常规数据

Pins Numbers/孔数	4pins/4针
Rated voltage/额定电压	630V
Rated current(40°C)/额定电流	12A
Standards/标准	IEC 61076-2-101
Termination/焊接方式	solder and over-mold/焊接和成型
Degree of protection/防护等级	IP67, IP68, IP69K
Wire gauge(mm²)/线规(平方数)	0.14mm²-0.75mm²
Wire gauge(AWG)/线号(平方数)	26AWG-18AWG
Mechanical operation/插拔次数	>100 mating cycles/大于100次
Contact resistance/接触电阻	≤5mΩ
Insulation resistance/绝缘电阻	≥100MΩ
Connector body/胶芯	TPU
Pins/端子	Phosphorus copper with gold plated/磷铜镀金
Screw/螺丝	Brass with nickel plated/黄铜镀镍
Environmental compliance/环境符合标准	RoHs, Reach

M12 T code female straight to female right angle molded cable, unshielded/M12, T型母头直头对母头弯头连接线, 不带屏蔽

Illustration/尺寸

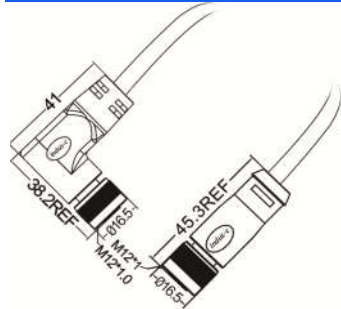

Product photo/产品图



Part number/产品料号

Pins/孔数	Code/型	Part number("X" is length millimetre mm)/产品料号("X"表示长度, 单位毫米mm)	
		PVC jacket/PVC外被	PUR jacket/PUR外被
4pins/4针	T code/T型	-40°C~+105°C	-40°C~+105°C
		12L01733-X	12L01734-X

Pin assignment front view/孔位分布前视图

T code 4pins
T型4孔

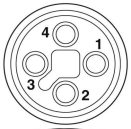

General data/常规数据

Pins Numbers/孔数	4pins/4针
Rated voltage/额定电压	630V
Rated current(40°C)/额定电流	12A
Standards/标准	IEC 61076-2-101
Termination/焊接方式	solder and over-mold/焊接和成型
Degree of protection/防护等级	IP67, IP68, IP69K
Wire gauge(mm²)/线规(平方数)	0.14mm²-0.75mm²
Wire gauge(AWG)/线号(平方数)	26AWG-18AWG
Mechanical operation/插拔次数	>100 mating cycles/大于100次
Contact resistance/接触电阻	≤5mΩ
Insulation resistance/绝缘电阻	≥100MΩ
Connector body/胶芯	TPU
Pins/端子	Phosphorus copper with gold plated/磷铜镀金
Screw/螺丝	Brass with nickel plated/黄铜镀镍
Environmental compliance/环境符合标准	RoHs, Reach

M12 T code female to female straight molded cable, unshielded/M12, T型母头直头对母头直头连接线, 不带屏蔽

Illustration/尺寸

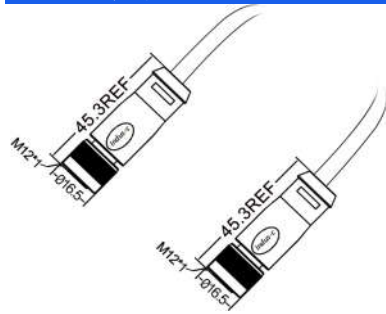

Product photo/产品图



Part number/产品料号

Pins/孔数	Code/型	Part number("X" is length millimetre mm)/产品料号("X"表示长度, 单位毫米mm)	
		PVC jacket/PVC外被	PUR jacket/PUR外被
4pins/4针	T code/T型	-40°C~+105°C	-40°C~+105°C
		12L01735-X	12L01736-X

Pin assignment front view/孔位分布前视图

T code 4pins
T型4孔

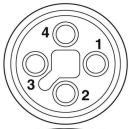

General data/常规数据

Pins Numbers/孔数	4pins/4针
Rated voltage/额定电压	630V
Rated current(40°C)/额定电流	12A
Standards/标准	IEC 61076-2-101
Termination/焊接方式	solder and over-mold/焊接和成型
Degree of protection/防护等级	IP67, IP68, IP69K
Wire gauge(mm²)/线规(平方数)	0.14mm²-0.75mm²
Wire gauge(AWG)/线号(平方数)	26AWG-18AWG
Mechanical operation/插拔次数	>100 mating cycles/大于100次
Contact resistance/接触电阻	≤5mΩ
Insulation resistance/绝缘电阻	≥100MΩ
Connector body/胶芯	TPU
Pins/端子	Phosphorus copper with gold plated/磷铜镀金
Screw/螺丝	Brass with nickel plated/黄铜镀镍
Environmental compliance/环境符合标准	RoHs, Reach

M12 T code male to male right angle molded cable, shielded/M12, T型公头弯头对公头弯头连接线, 带屏蔽

Illustration/尺寸

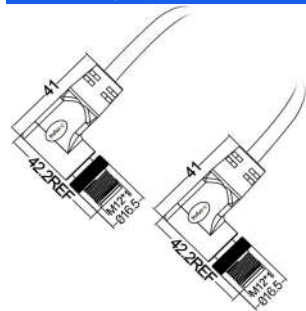

Product photo/产品图



Part number/产品料号

Pins/针数	Code/型	Part number("X" is length millimetre mm)/产品料号("X"表示长度, 单位毫米mm)	
		PVC jacket/PVC外被	PUR jacket/PUR外被
4pins/4针	T code/T型	-40°C~+105°C	-40°C~+105°C
		12L01697-X	12L01698-X

Pin assignment front view/针位分布前视图

T code 4pins
T型4针



General data/常规数据

Pins Numbers/针数	4pins/4针
Rated voltage/额定电压	630V
Rated current(40°C)/额定电流	12A
Standards/标准	IEC 61076-2-101
Termination/焊接方式	solder and over-mold/焊接和成型
Degree of protection/防护等级	IP67, IP68, IP69K
Wire gauge(mm²)/线规(平方数)	0.14mm²-0.75mm²
Wire gauge(AWG)/线号(平方数)	26AWG-18AWG
Mechanical operation/插拔次数	>100 mating cycles/大于100次
Contact resistance/接触电阻	≤5mΩ
Insulation resistance/绝缘电阻	≥100MΩ
Connector body/胶芯	TPU
Pins/端子	Brass with gold plated/黄铜镀金
Screw/螺丝	Brass with nickel plated/黄铜镀镍
Environmental compliance/环境符合标准	RoHs, Reach

M12 T code male to female right angle molded cable, shielded/M12, T型公头弯头对母头弯头连接线, 带屏蔽

Illustration/尺寸

Product photo/产品图

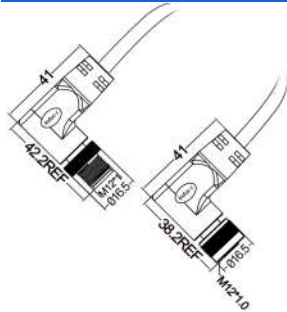

Part number/产品料号

Pins/针数	Code/型	Part number("X" is length millimetre mm)/产品料号("X"表示长度, 单位毫米mm)	
		PVC jacket/PVC外被	PUR jacket/PUR外被
4pins/4针	T code/T型	-40°C~+105°C	-40°C~+105°C
		12L01699-X	12L01700-X

Pin assignment front view/针位分布前视图

T code 4pins
T型4针

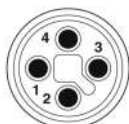

T code 4pins
T型4孔

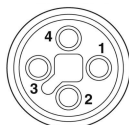

General data/常规数据

Pins Numbers/针数	4pins/4针
Rated voltage/额定电压	630V
Rated current(40°C)/额定电流	12A
Standards/标准	IEC 61076-2-101
Termination/焊接方式	solder and over-mold/焊接和成型
Degree of protection/防护等级	IP67, IP68, IP69K
Wire gauge(mm²)/线规(平方数)	0.14mm²-0.75mm²
Wire gauge(AWG)/线号(平方数)	26AWG-18AWG
Mechanical operation/插拔次数	>100 mating cycles/大于100次
Contact resistance/接触电阻	≤5mΩ
Insulation resistance/绝缘电阻	≥100MΩ
Connector body/胶芯	TPU
Male pin/公端子	Brass with gold plated/黄铜镀金
Female pin/母端子	Phosphorus copper with gold plated/磷铜镀金
Screw/螺丝	Brass with nickel plated/黄铜镀镍
Over-mold/成型	TPU
Environmental compliance/环境符合标准	RoHS, Reach

M12 T code male right angle to female straight molded cable, shielded/M12, T型公头弯头对母头直头成型式连接线, 带屏蔽

Illustration/尺寸

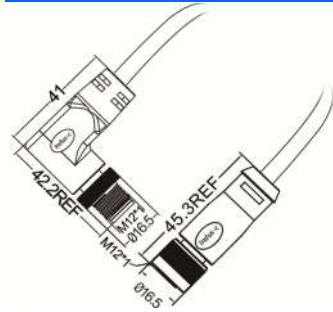

Product photo/产品图



Part number/产品料号

Pins/针数	Code/型	Part number("X" is length millimetre mm)/产品料号("X"表示长度, 单位毫米mm)	
		PVC jacket/PVC外被	PUR jacket/PUR外被
4pins/4针	T code/T型	-40°C~+105°C	-40°C~+105°C
		12L01701-X	12L01702-X

Pin assignment front view/针位分布前视图

T code 4pins
T型4针



T code 4pins
T型4孔

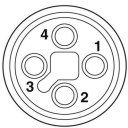

General data/常规数据

Pins Numbers/针数	4pins/4针
Rated voltage/额定电压	630V
Rated current(40°C)/额定电流	12A
Standards/标准	IEC 61076-2-101
Termination/焊接方式	solder and over-mold/焊接和成型
Degree of protection/防护等级	IP67, IP68, IP69K
Wire gauge(mm²)/线规(平方数)	0.14mm²-0.75mm²
Wire gauge(AWG)/线号(平方数)	26AWG-18AWG
Mechanical operation/插拔次数	>100 mating cycles/大于100次
Contact resistance/接触电阻	≤5mΩ
Insulation resistance/绝缘电阻	≥100MΩ
Connector body/胶芯	TPU
Male pin/公端子	Brass with gold plated/黄铜镀金
Female pin/母端子	Phosphorus copper with gold plated/磷铜镀金
Screw/螺丝	Brass with nickel plated/黄铜镀镍
Over-mold/成型	TPU
Environmental compliance/环境符合标准	RoHS, Reach

M12 T code male straight to male right angle molded cable, shielded/M12, T型公头直头对公头弯头连接线, 带屏蔽

Illustration/尺寸



Product photo/产品图



Part number/产品料号

Pins/针数	Code/型	Part number("X" is length millimetre mm)/产品料号("X"表示长度, 单位毫米mm)	
		PVC jacket/PVC外被	PUR jacket/PUR外被
4pins/4针	T code/T型	-40°C~+105°C	-40°C~+105°C
		12L01703-X	12L01704-X

Pin assignment front view/针位分布前视图

T code 4pins
T型4针



General data/常规数据

Pins Numbers/针数	4pins/4针
Rated voltage/额定电压	630V
Rated current(40°C)/额定电流	12A
Standards/标准	IEC 61076-2-101
Termination/焊接方式	solder and over-mold/焊接和成型
Degree of protection/防护等级	IP67, IP68, IP69K
Wire gauge(mm²)/线规(平方数)	0.14mm²-0.75mm²
Wire gauge(AWG)/线号(平方数)	26AWG-18AWG
Mechanical operation/插拔次数	>100 mating cycles/大于100次
Contact resistance/接触电阻	≤5mΩ
Insulation resistance/绝缘电阻	≥100MΩ
Connector body/胶芯	TPU
Pins/端子	Brass with gold plated/黄铜镀金
Screw/螺丝	Brass with nickel plated/黄铜镀镍
Environmental compliance/环境符合标准	RoHs, Reach

M12 T code male to male straight molded cable, shielded/M12, T型公头直头对公头直头连接线, 带屏蔽

Illustration/尺寸

Product photo/产品图



Part number/产品料号

Pins/针数	Code/型	Part number("X" is length millimetre mm)/产品料号("X"表示长度, 单位毫米mm)	
		PVC jacket/PVC外被	PUR jacket/PUR外被
4pins/4针	T code/T型	-40°C~+105°C 12L01705-X	-40°C~+105°C 12L01706-X

Pin assignment front view/针位分布前视图

T code 4pins
T型4针



General data/常规数据

Pins Numbers/针数	4pins/4针
Rated voltage/额定电压	630V
Rated current(40°C)/额定电流	12A
Standards/标准	IEC 61076-2-101
Termination/焊接方式	solder and over-mold/焊接和成型
Degree of protection/防护等级	IP67, IP68, IP69K
Wire gauge(mm²)/线规(平方数)	0.14mm²-0.75mm²
Wire gauge(AWG)/线号(平方数)	26AWG-18AWG
Mechanical operation/插拔次数	>100 mating cycles/大于100次
Contact resistance/接触电阻	≤5mΩ
Insulation resistance/绝缘电阻	≥100MΩ
Connector body/胶芯	TPU
Pins/端子	Brass with gold plated/黄铜镀金
Screw/螺丝	Brass with nickel plated/黄铜镀镍
Environmental compliance/环境符合标准	RoHs, Reach

M12 T code male straight to female right angle molded cable, shielded/M12, T型公头直头对母头弯头连接线, 带屏蔽

Illustration/尺寸

Product photo/产品图

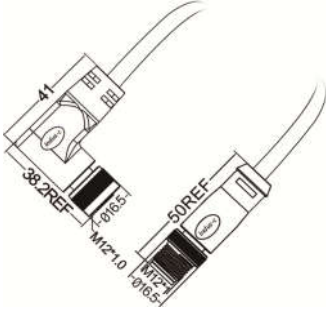

Part number/产品料号

Pins/针数	Code/型	Part number("X" is length millimetre mm)/产品料号("X"表示长度, 单位毫米mm)	
		PVC jacket/PVC外被	PUR jacket/PUR外被
4pins/4针	T code/T型	-40°C~+105°C	-40°C~+105°C
		12L01707-X	12L01708-X

Pin assignment front view/针位分布前视图

T code 4pins
T型4针



T code 4pins
T型4孔



General data/常规数据

Pins Numbers/针数	4pins/4针
Rated voltage/额定电压	630V
Rated current(40°C)/额定电流	12A
Standards/标准	IEC 61076-2-101
Termination/焊接方式	solder and over-mold/焊接和成型
Degree of protection/防护等级	IP67, IP68, IP69K
Wire gauge(mm²)/线规(平方数)	0.14mm²-0.75mm²
Wire gauge(AWG)/线号(平方数)	26AWG-18AWG
Mechanical operation/插拔次数	>100 mating cycles/大于100次
Contact resistance/接触电阻	≤5mΩ
Insulation resistance/绝缘电阻	≥100MΩ
Connector body/胶芯	TPU
Male pin/公端子	Brass with gold plated/黄铜镀金
Female pin/母端子	Phosphorus copper with gold plated/磷铜镀金
Screw/螺丝	Brass with nickel plated/黄铜镀镍
Over-mold/成型	TPU
Environmental compliance/环境符合标准	RoHS, Reach

M12 T code male to female straight molded cable, shielded/M12, T型公头直头对母头直头连接线, 带屏蔽

Illustration/尺寸

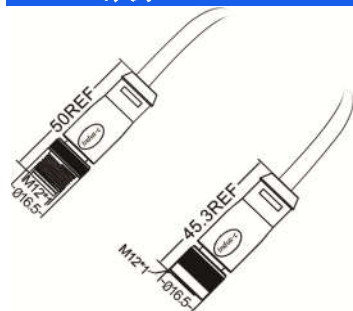

Product photo/产品图



Part number/产品料号

Pins/针数	Code/型	Part number("X" is length millimetre mm)/产品料号("X"表示长度, 单位毫米mm)	
		PVC jacket/PVC外被	PUR jacket/PUR外被
4pins/4针	T code/T型	-40°C~+105°C 12L01709-X	-40°C~+105°C 12L01710-X

Pin assignment front view/针位分布前视图

T code 4pins
T型4针



T code 4pins
T型4孔

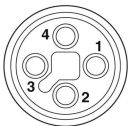

General data/常规数据

Pins Numbers/针数	4pins/4针
Rated voltage/额定电压	630V
Rated current(40°C)/额定电流	12A
Standards/标准	IEC 61076-2-101
Termination/焊接方式	solder and over-mold/焊接和成型
Degree of protection/防护等级	IP67, IP68, IP69K
Wire gauge(mm²)/线规(平方数)	0.14mm²-0.75mm²
Wire gauge(AWG)/线号(平方数)	26AWG-18AWG
Mechanical operation/插拔次数	>100 mating cycles/大于100次
Contact resistance/接触电阻	≤5mΩ
Insulation resistance/绝缘电阻	≥100MΩ
Connector body/胶芯	TPU
Male pin/公端子	Brass with gold plated/黄铜镀金
Female pin/母端子	Phosphorus copper with gold plated/磷铜镀金
Screw/螺丝	Brass with nickel plated/黄铜镀镍
Over-mold/成型	TPU
Environmental compliance/环境符合标准	RoHS, Reach

M12 T code female to female right angle molded cable, shielded/M12, T型母头弯头对母头弯头连接线, 带屏蔽

Illustration/尺寸

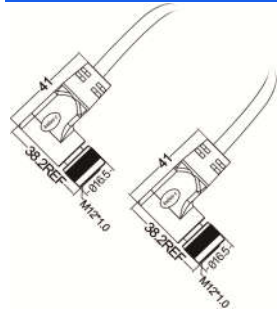

Product photo/产品图



Part number/产品料号

Pins/孔数	Code/型	Part number("X" is length millimetre mm)/产品料号("X"表示长度, 单位毫米mm)	
		PVC jacket/PVC外被	PUR jacket/PUR外被
4pins/4针	T code/T型	-40°C~+105°C	-40°C~+105°C
		12L01711-X	12L01712-X

Pin assignment front view/孔位分布前视图

T code 4pins
T型4孔

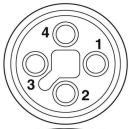

General data/常规数据

Pins Numbers/孔数	4pins/4针
Rated voltage/额定电压	630V
Rated current(40°C)/额定电流	12A
Standards/标准	IEC 61076-2-101
Termination/焊接方式	solder and over-mold/焊接和成型
Degree of protection/防护等级	IP67, IP68, IP69K
Wire gauge(mm²)/线规(平方数)	0.14mm²-0.75mm²
Wire gauge(AWG)/线号(平方数)	26AWG-18AWG
Mechanical operation/插拔次数	>100 mating cycles/大于100次
Contact resistance/接触电阻	≤5mΩ
Insulation resistance/绝缘电阻	≥100MΩ
Connector body/胶芯	TPU
Pins/端子	Phosphorus copper with gold plated/磷铜镀金
Screw/螺丝	Brass with nickel plated/黄铜镀镍
Environmental compliance/环境符合标准	RoHs, Reach

M12 T code female straight to female right angle molded cable, shielded/M12, T型母头直头对母头弯头连接线, 带屏蔽

Illustration/尺寸

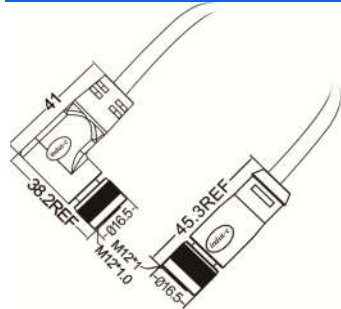

Product photo/产品图



Part number/产品料号

Pins/孔数	Code/型	Part number("X" is length millimetre mm)/产品料号("X"表示长度, 单位毫米mm)	
		PVC jacket/PVC外被	PUR jacket/PUR外被
4pins/4针	T code/T型	-40°C~+105°C 12L01713-X	-40°C~+105°C 12L01714-X

Pin assignment front view/孔位分布前视图

T code 4pins
T型4孔

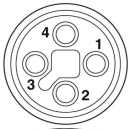

General data/常规数据

Pins Numbers/孔数	4pins/4针
Rated voltage/额定电压	630V
Rated current(40°C)/额定电流	12A
Standards/标准	IEC 61076-2-101
Termination/焊接方式	solder and over-mold/焊接和成型
Degree of protection/防护等级	IP67, IP68, IP69K
Wire gauge(mm²)/线规(平方数)	0.14mm²-0.75mm²
Wire gauge(AWG)/线号(平方数)	26AWG-18AWG
Mechanical operation/插拔次数	>100 mating cycles/大于100次
Contact resistance/接触电阻	≤5mΩ
Insulation resistance/绝缘电阻	≥100MΩ
Connector body/胶芯	TPU
Pins/端子	Phosphorus copper with gold plated/磷铜镀金
Screw/螺丝	Brass with nickel plated/黄铜镀镍
Environmental compliance/环境符合标准	RoHs, Reach

M12 T code female to female straight molded cable, shielded/M12, T型母头直头对母头直头连接线, 带屏蔽

Illustration/尺寸

Product photo/产品图

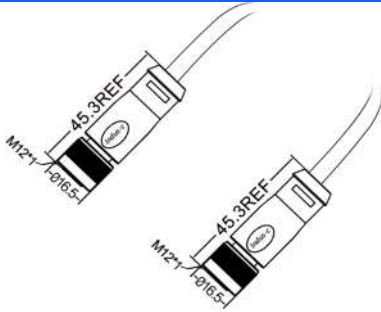

Part number/产品料号

Pins/孔数	Code/型	Part number("X" is length millimetre mm)/产品料号("X"表示长度, 单位毫米mm)	
		PVC jacket/PVC外被	PUR jacket/PUR外被
4pins/4针	T code/T型	-40°C~+105°C	-40°C~+105°C
		12L01715-X	12L01716-X

Pin assignment front view/孔位分布前视图

T code 4pins
T型4孔



General data/常规数据

Pins Numbers/孔数	4pins/4针
Rated voltage/额定电压	630V
Rated current(40°C)/额定电流	12A
Standards/标准	IEC 61076-2-101
Termination/焊接方式	solder and over-mold/焊接和成型
Degree of protection/防护等级	IP67, IP68, IP69K
Wire gauge(mm²)/线规(平方数)	0.14mm²-0.75mm²
Wire gauge(AWG)/线号(平方数)	26AWG-18AWG
Mechanical operation/插拔次数	>100 mating cycles/大于100次
Contact resistance/接触电阻	≤5mΩ
Insulation resistance/绝缘电阻	≥100MΩ
Connector body/胶芯	TPU
Pins/端子	Phosphorus copper with gold plated/磷铜镀金
Screw/螺丝	Brass with nickel plated/黄铜镀镍
Environmental compliance/环境符合标准	RoHs, Reach